

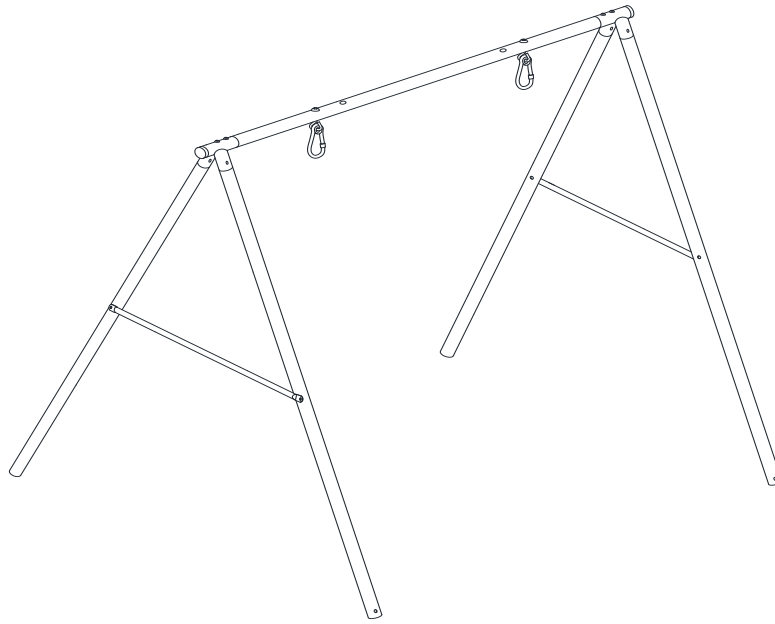

Model # 71901

WHITE LAWN SWING FRAME



Assembled dimensions are 82" x 69.5" x 74"

**FITS MOST STANDARD FOUR (4) AND FIVE (5) FOOT WIDE LAWN SWING SEATS
OWNER'S MANUAL, ASSEMBLY INSTRUCTIONS, CARE, MAINTENANCE AND USER'S GUIDE**



WARNING!

Please read this entire instruction and assembly manual completely before proceeding. You must follow all safety instructions while using this equipment. The surface area where this lawn swing frame is set up must be level and free of all debris. This frame is designed to be anchored into the ground and is not to be set up on any hard surfaces such as concrete, hardened soil, or asphalt. Proper surfacing under and surrounding the set adds to the safety level such as sand or mulch. Read all cautionary statements on the following pages before using this equipment and save this instruction manual. **DO NOT ALLOW CHILDREN TO PLAY ON THIS FRAME!** Do not use when raining or during any inclement weather (i.e. rain, sleet, snow, ice, high winds, thunder storms, or lightning). **DO NOT ALLOW CHILDREN TO JUMP ON OR CLIMB UP ON THIS FRAME'S TOP BAR.**

For warranty details and registration card see the back page of this manual.
FOLLOW ALL ASSEMBLY INSTRUCTIONS AS WRITTEN IN THIS MANUAL

Please retain sales receipt for warranty purposes. DO NOT RETURN THE

SET TO THE STORE. If replacement parts or customer service is needed please contact XDP Recreation by

email at service@xdp-recreation.com or by calling 1-866-884-0535 between 8:00am and 5:00pm (Eastern Standard Time),

Monday - Friday. This frame is designed to be used safely with a **total combined weight, including the lawn swing**

seat (not included) of six-hundred (600) pounds (272.15 kgs). This frame is designed for backyard use only and is NOT

intended for playgrounds, parks, schools, day care facilities, nurseries or other public places. **Follow all assembly**

instructions carefully and as directed in this manual. This frame conforms to all safety requirements by ASTM for

Home Playground equipment when properly assembled using the instructions enclosed. Adult assembly is required.

Contains small parts. **For proper stability and safety this lawn swing frame should be installed with ground anchors.**

These can be purchased from the store where you bought the frame from or by buying them from XDP Recreation

at www.xdp-recreation.com

XDP RECREATION LLC, 5910 SHILOH ROAD EAST, UNIT 108, ALPHARETTA, GEORGIA 30005

IMPORTANT INSTRUCTIONS AND WARNINGS



READ ALL INSTRUCTIONS BEFORE ASSEMBLING OR USING THIS EQUIPMENT

HARDWARE AND SWING BEARINGS ARE INCLUDED - CHAINS ARE NOT INCLUDED.

AGE LIMIT

- This product is designed to be used with lawn swings which will fit this frame properly. **TOTAL MAXIMUM USER WEIGHT INCLUDING THE LAWN SWING (which is not included) is 600 pounds (272.15 kgs).**
- This unit is not designed for children or to hold any other type of attachment except for a lawn swing!
- Do not allow use by adults with any physical condition that may affect his/her ability to use this equipment safely.
- Chains are NOT included with this frame.

BEFORE YOU BEGIN

- Carefully read all instructions in this manual before assembling and using this product.
- The unit must be assembled by adults. Heavy duty working gloves must be worn to avoid injuries during assembly.
- Adults must not use the equipment until it is properly assembled and anchored.
- Unpack all parts. Take a complete inventory of all parts and hardware using the parts and hardware lists in the following pages. If any parts are missing, do not return to the store. Please call customer service toll-free number listed on the cover page for assistance. Store the product back in the original box and do not begin to install until all parts are obtained.

LOCATION OF LAWN SWING FRAME

- The equipment must be placed more than six (6) feet (1.8 meters) from any structures or obstructions, including but not limited to buildings, fence, garage, trees, laundry lines, electrical wires.
- **The FRAME must be installed on level ground.** Uneven ground must be leveled prior to installation. Installation on sloping or uneven ground will put stress on the joints, causing the unit to become loose and unstable which may result in serious injuries.
- Remove any tripping hazards from the safe swing area, such as roots, tree stumps, rocks, landscaping, sprinkler heads, railroad ties, plumbing and electrical connections.
- **Windy conditions: it is possible for the product to be blown about by a high wind. if you anticipate high winds, the frame should be secured to the ground with the use of an Anchor kit. If you anticipate severe winds, the product should be moved to a sheltered location or completely disassembled. Anchor kits can be ordered directly from XDP RECREATION at <https://www.xdp-recreation.com> or by calling 1-866-844-0535.**

- **Do not install lawn swing frame over hard surface, e.g. asphalt, concrete, packed earth, tile or brick floor. A fall onto a hard surface can result in serious injury or death to the user.** The following is a list of recommended ground covers from the Consumer Product Safety Commission:

<u>SUGGESTED MATERIAL</u>	<u>UNCOMPRESSED DEPTH</u>
Double Shredded Bark Mulch	9"
Uniform Wood Chips	12"
Fine Gravel	12"
Fine Sand	12"

The Consumer Product Safety Commission's Outdoor Home Playground Safety Handbook recommends to install and maintain the playground equipment over at least 9 inches of wood chips, mulch or shredded rubber (for equipment up to 8 feet high) or sand or pea gravel (for equipment no more than 5 feet high) as shock absorbing material. Dirt and grass, which are the most prevalent surfaces under home playground equipment, do not adequately protect children from serious head injuries. Install protective surfacing at least six feet in all directions from play equipment. For swings, the surface should extend, in back and front, twice the height of the suspending bar. You should consult a local contractor about ways to secure the product in your location. Do not install your play set over hard surface, e.g. asphalt, concrete, packed earth, tile or brick floor. Please refer to the CONSUMER PRODUCT SAFETY COMMISSION'S OUTDOOR HOME PLAYGROUND SAFETY HANDBOOK for detailed guidelines to prevent injuries from falls and other hazards on public and home playgrounds.

WARNINGS ON ANCHORING

It is highly recommended the product be anchored into the ground to prevent movement and to make the LAWN SWING FRAME more stable during use.

Some consumers want an anchoring system that allows the product to be moved to different locations. Other consumers want to keep their swing set in a permanent location.

It is highly recommended that you seek the opinion from a local licensed contractor on the best way to secure the lawn swing frame in your location. The best way to anchor a product is to create a concrete footing and use that as a base for an anchor. Whatever method you prefer for your location, an anchoring system for this product should be used at all times.

WEATHER CONDITIONS

- Please be aware of weather conditions when using the equipment. If it is too windy, users could lose control and suffer injuries. The frame must be properly anchored, stored away or restricted from use during inclement weather such as heavy winds or severe weather storms. You should consult a local contractor about ways to anchor the product in your location.
- If you wish to use ground anchors, they can be purchased from the store you bought this frame from or by ordering directly from XDP Recreation at <https://www.xdp-recreation.com> or by calling 1-866-884-0535 Monday through Friday 9am - 5pm Eastern Standard Time.

INSPECTION PRIOR TO EACH USE OR DAILY INSPECTION

- **DO NOT** use the equipment if any bolts or nuts are missing or loose. **ALWAYS** check to ensure the equipment and all parts are well secured and stable before each use.
- **ALWAYS** clear the area of any rocks, sharp objects, or any materials that could be potentially hazardous to users.
- **DO NOT** attach items to the equipment that are not specifically designed for use with the equipment, including, but not limited to, jump ropes, clothesline, pet leashes, cables and chains, or children's swings as they may cause choke hazards and the product is not designed for any of these components.
- The steel and plastic parts used in your product are subject to normal wear. Gradual deterioration of the material will occur, the speed of which will depend on the level of exposure to UV rays, airborne pollution, outdoor weather conditions such as rain and wind and the amount of use. You must inspect the equipment prior to every use. This includes, but is not limited to inspecting the set for cracks, excess wear, missing parts, loose connections, and for overall integrity. When the set shows any signs of weakness, you must stop using the play set immediately, properly store the set or restrict access by users until the condition is resolved.

When conducting inspections, it is recommended that you use the Suggested General Maintenance Checklist and Routine Inspection and Maintenance Issues checklists provided by the US Consumer Product Safety Commission, a copy of which is contained in this user manual.

CARE & MAINTENANCE INSTRUCTIONS

- Inspect all nuts and bolts twice monthly during the usage season for tightness and tighten as required. It is particularly important that this procedure is followed at the beginning of each season.
- Oil all metallic moving parts monthly during the usage period.
- Sand rusted areas on metal tubing and repaint using a nonlead-based paint meeting the requirements of Title 16 CFR Part 1303.
- Check all coverings for bolts and sharp edges twice monthly during usage season to be certain that they are in place and replace when necessary. It is especially important to do this at the beginning of each new season.
- Do not use when the temperature drops below 32 degrees F (0 degrees C); remove and store your lawn swing from the frame.

XDP RECREATION DOES NOT WARRANT ANY LAWN SWING WHICH IS ATTACHED BY THE PURCHASER TO THIS FRAME. THIS FRAME IS DESIGNED AS A REPLACEMENT ONLY. IT IS THE CONSUMERS RESPONSIBILITY TO ENSURE THAT THE FRAME MEETS THE REQUIREMENTS OF THEIR OWN LAWN SWING SEAT AND ALL WEIGHT RESTRICTIONS FOR THIS FRAME (600 LBS MAXIMUM WEIGHT CAPACITY).

ANCHORING

(NOTE: ANCHORS ARE NOT INCLUDED- MUST BE PURCHASED SEPARATELY)

There are different ways of anchoring the equipment, depending on the type of ground on which the equipment is to be installed. Make sure that all anchors are below ground level to prevent tripping.

You should consult your local contractor to decide the most appropriate way to anchor the equipment in your location.

The following anchoring options may be considered:

Corkscrew Anchoring (Corkscrew Anchors not included)

- If your soil is hard (clay, etc.), the corkscrew method may be suitable.
- Be sure that the swing set is located on level ground.
- Twist the corkscrew anchor into the ground until only the end with the hook is above the ground and next to the leg. Insert the hook into the bottom opening of the leg. Ensure that the hook is secured onto the leg opening.

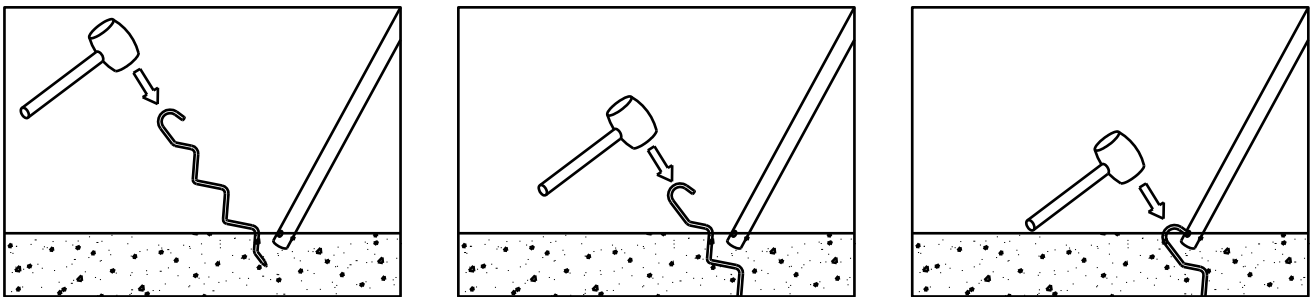

GROUND ANCHORS ARE NOT INCLUDED WITH THIS FRAME - THEY MUST BE BOUGHT SEPERATELY. PLEASE CONSULT THE PROPER INSTRUCTION GUIDE THAT COMES WITH YOUR GROUND ANCHOR KIT TO ENSURE PROPER INSTALLATION WITH THIS FRAME.

Concrete Anchoring (Materials not included)

- If the swing set is set up on grounds with sandy soil (soft) condition, it must be anchored with concrete footing (concrete not included)
- Be sure that the swing set is assembled and placed on level ground
- Dig holes around swing leg tube, as shown in drawing in the next page. As you dig deeper, enlarge the diameter of the hole to fix the cement
- Place 2 inches of brick or gravel underneath the leg, as shown in drawing in the next page
- Use about 45 lbs. of concrete per leg
- Cover the concrete with dirt and protective surface material
- Allow 6-7 days for the concrete to dry properly

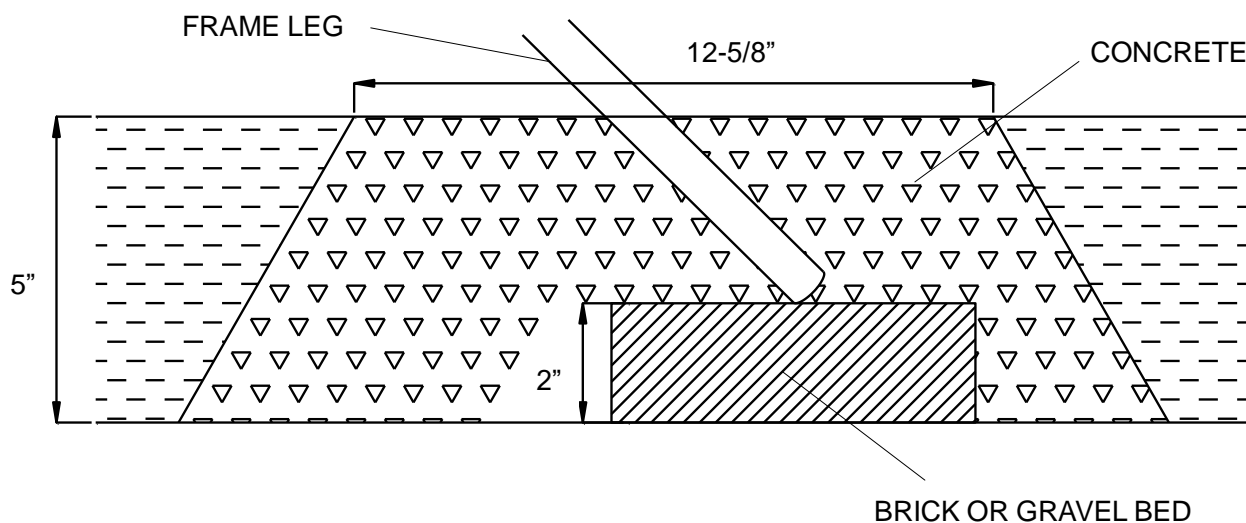

Note: The maximum fall height for this product is 6 feet. The minimum ground clearance between the bottom of the suspended plays and the playing or ground surface must be 8 inches.

You must maintain a minimum of 8 inches of ground clearance.

⚠ WARNING

Please properly anchor the lawn swing frame to minimize the risk of injury. If the lawn swing frame is used without proper anchoring, it may be dangerous and may tilt over.

CARE AND MAINTENANCE CHECKLIST

GENERAL MAINTENANCE SUGGESTIONS

AT THE BEGINNING OF EACH SEASON AND DURING THE COURSE OF THE SEASON:

- Tighten all hardware.
- Lubricate all metallic moving parts.
- Check all protective coverings on bolts, pipes, edges, and corners. Replace if they are loose, cracked, or missing.
- Check all moving parts including swing seats and chains for wear, rust or other deterioration. Replace as needed.
- Check metal parts for rust. If found, sand and repaint using a non-lead paint meeting the requirements of 16 CFR 1303.
- Rake and check depth of loose fill protective surfacing materials to prevent compaction and to maintain appropriate depth. Replace as needed.

As a general rule, maintenance should be performed at any time it is deemed necessary.

DISPOSAL INSTRUCTIONS

- ◆ Please use care when disassembling the equipment, when it is no longer in operational condition. Wear heavy duty working gloves to avoid injuries.
- ◆ Fully disassemble the entire frame. Do not leave partially disassembled parts in areas accessible by children.
- ◆ Should you wish to recycle the steel tubing, please take the frame to your local recycling center.
- ◆ All plastic parts can be recycled, take it to your local recycling center. Do not let children play with any disassembled parts meant for disposal, such as chains, tubing, bolts, nuts, screws, etc.
- ◆ All rusted parts, bolts must be properly disposed of in trash bin. Do not reuse.

Owners shall be responsible for maintaining the legibility of the warning labels.

TOOLS NEEDED

Please prepare the following tools
prior to assembling this equipment.

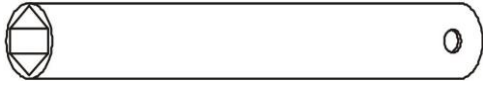

**Special Socket Wrench
(Not included)**

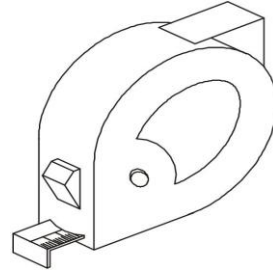

**Tape Measure
(Not included)**

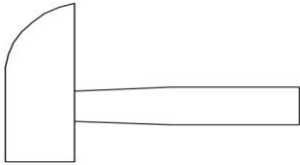

**Hammer
(If you intend to install anchor, this is needed)**

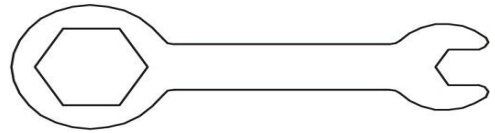

**Wrench
(Included)**

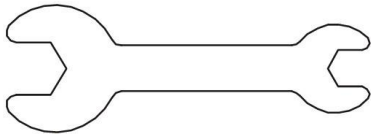

**Wrench
(Not included))**

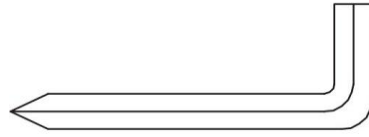

**Big Allen Wrench
(Included)**

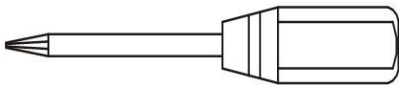

**Flat Head and Philips Head Screwdriver
(Not included)**







**Middle Allen Wrench
(Not included)**











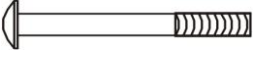
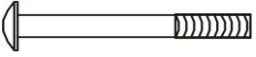

**Small Allen Wrench
(Not Included)**

Part list for main frame assembly

A1		WELDING THE BEAM	1
A2		TOP BAR	2
A3		LEG	4
A4		CROSS BAR	2
C2		END CAP (PRE-ASSEMBLED)	2

Hardware used for main frame assembly

B1		BOLT 5/16" * 2-1/2" (63MM)	6
B2		BOLT 5/16" * 2-5/8" (68MM)	4
B3		NYLON NUT 5/16"	10
B4		PLASTIC CAP (WITH ARC WASHER)	10
B5		ARC WASHER $\Phi 8.5 \Phi 19 * T1.5MM$	8
B6		ARC WASHER $\Phi 25 \Phi 13 * T2.0MM$	2
B7		FLAT WASHER $\Phi 8.5 \Phi 19 * T1.5MM$	4
B8		BOLT M8 * 20	2
B9		SPRING WASHER $\Phi 8.5 \Phi 13 * T2.0MM$	2
B10		SPRING WASHER $\Phi 20 \Phi 13.3 * T3.0MM$	2
B11		Carabiner hook with attachment bolt	2
B12		BOLT $\Phi 12.5 * 24mm$	2

ASSEMBLY INSTRUCTIONS

- Place the **LAWN SWING FRAME** on level ground and not less than 6ft (1.8m) from any structure or obstruction such as a fence, garage, house, overhanging branches, laundry line, or electrical wires.
- Do not install the **LAWN SWING FRAME** over concrete, asphalt, packed earth, or any other hard surface; a fall onto a hard surface can result in serious injury or death to the equipment user.
- **Adequate overhead clearance is essential.** A minimum clearance from ground level shall be recommended. Provide clearance for wires, tree limbs, and other possible hazards.

TIGHTENING NUTS & BOLTS

- For ease of installation, do not over-tighten the nuts and bolts when you are first putting the equipment together. This will allow for some possible adjustments during installation.
- **Once you have finished assembling each component of the play set, make sure to go back over each step and properly tighten all nuts, bolts and plastic caps.** Check the entire unit to ensure all parts are properly assembled before allowing children to use the playground equipment.

STEP 1 – Assemble the top bar frame of the swing set

- Connect A1 to A2 and secure using B3, B4, B5, B1, B8, B9, B6 and B2 as shown below.
- Repeat the above step for the right side of the swing set .

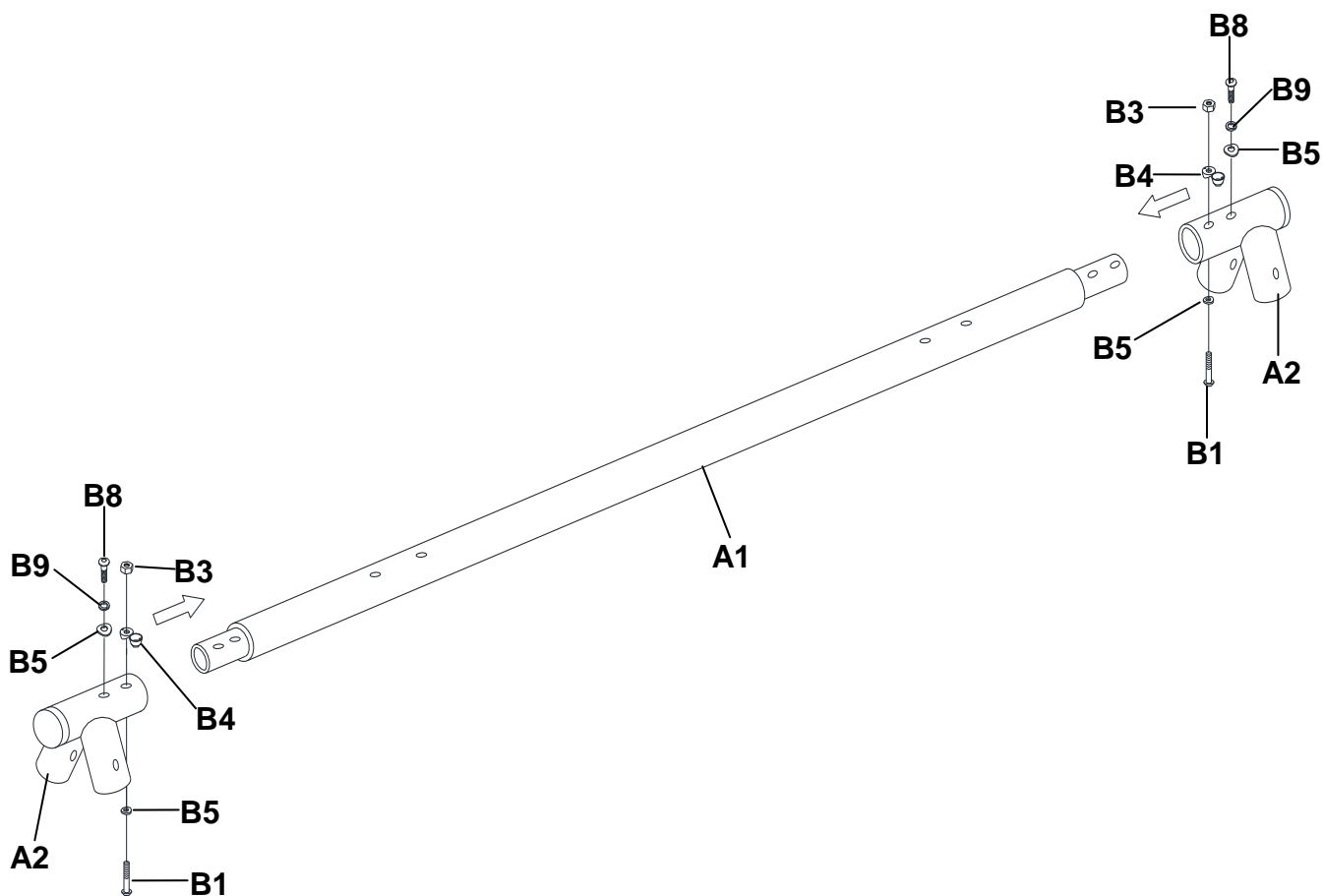

STEP 2 – Attach the crossbar to the support legs

- Attach A3 to the outer side of A2 and secure using B1, B5, B4 and B3.
- Repeat the above step for the right side of the swing set .

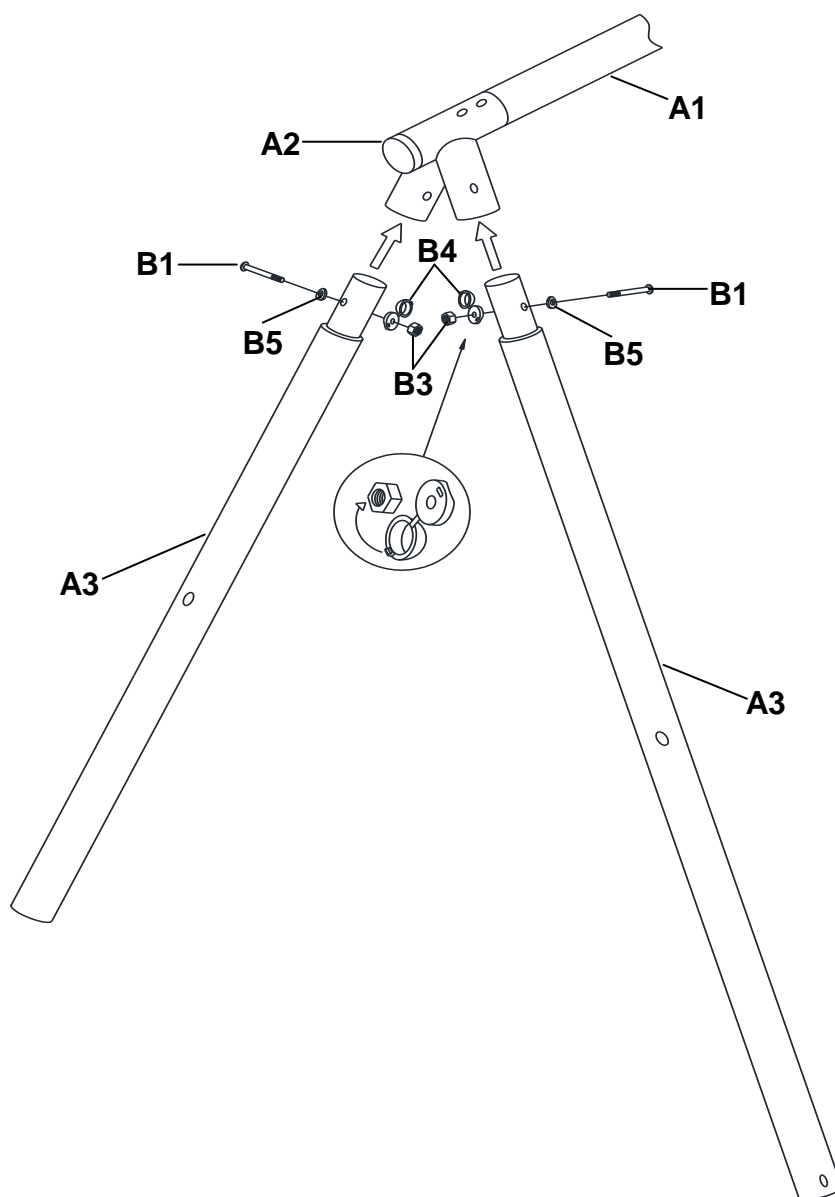

NOTE:

1. Do not over-tighten the nuts and bolts at every step.
2. Do not snap in the cover of plastic cap until you have finished the assembly of each step and went back to tighten all of the nuts and bolts.

STEP 3 – Attach the crossbar to the legs (cont).

- Attach A4 to the outer side of A3 and secure using B2, B7, B4 and B3.

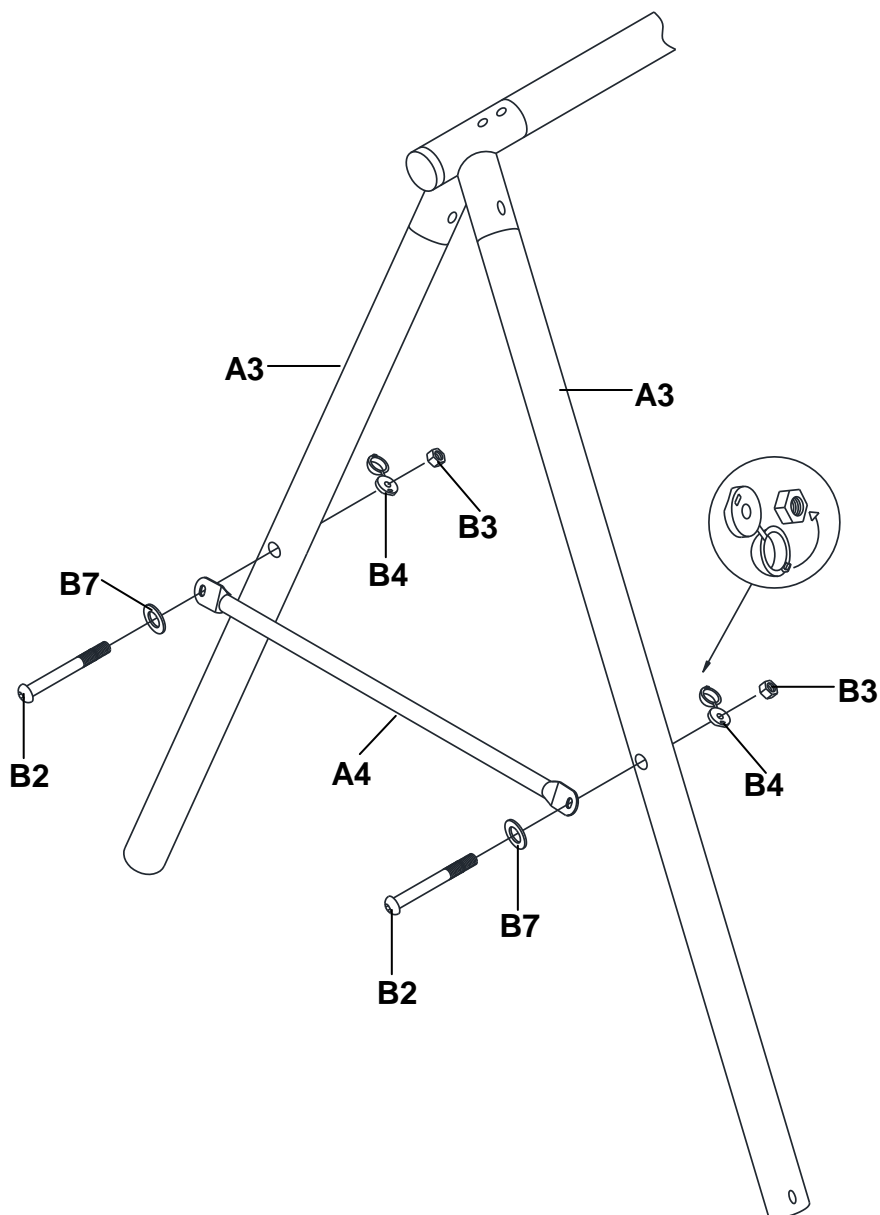

STEP 4 – Swing Bearing Assembly

- Attach B11 to the outer side of A1 and secure using B6, B10, and B12.
- Repeat the same action on the other side

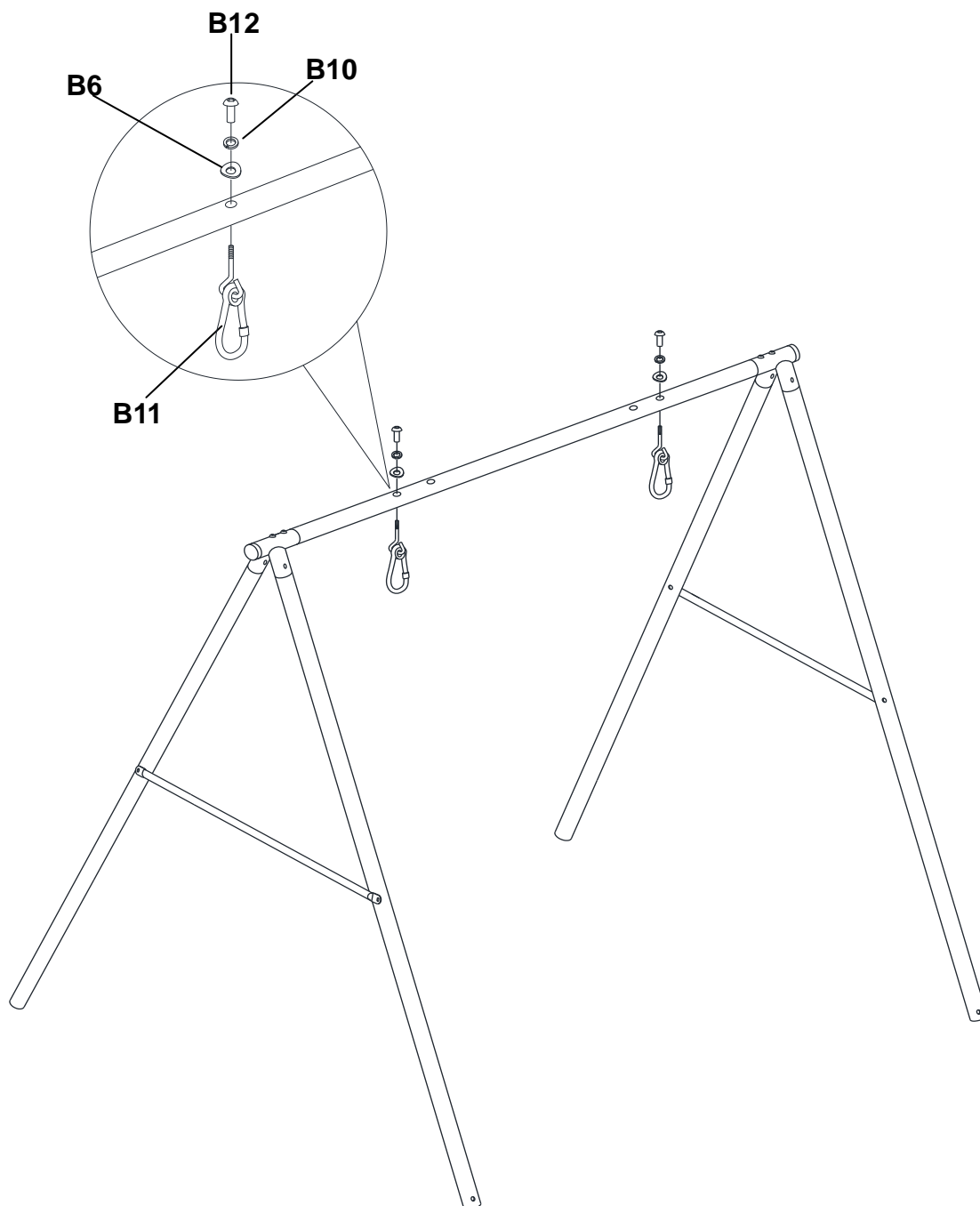

Congratulations! You have now completed the LAWN SWING FRAME assembly. Please make sure to thoroughly check all parts and hardware to make sure all bolts and nuts are well secured before using the playground equipment.



WARNING:

Do not let adults use the LAWN SWING FRAME until it is properly assembled and anchored.





Dear Customer:

Thank you for your purchase of an XDP Recreation lawn swing frame. **By following the instruction manual, reading all safety and assembly instructions, and properly anchoring your frame in the ground, you should safely enjoy hours of enjoyment.** Detailed below is our warranty covering your purchase. Please be sure to read it and contact us in the event you need service or parts. **DO NOT RETURN THE SET TO THE STORE YOU PURCHASED IT.**

Sincerely,
XDP Recreation LLC

MANUFACTURER'S LIMITED WARRANTY

What does this Limited Warranty cover?

This warranty covers your XDP Recreation product for one hundred and eight (180) days against defects in material, workmanship, and rust on painted parts which compromise the structural integrity of the product when used for the purpose intended, normal outdoor conditions, and **provided it is assembled correctly** as illustrated in this manual and receives the proper care and maintenance. NOTE: *Surface rust is not covered under this warranty.*

Who does this Limited Warranty Cover?

This warranty is extended only to the original purchaser with a receipt and is **not** transferrable.

What will XDP Recreation do?

They will provide a replacement part at no charge for any part found defective during the warranty period.

What does this warranty **NOT** cover?

This limited warranty **does not** cover XDP Recreation products which: fail due to (1) normal wear; (2) abuse and misuse; (3) improper maintenance; (4) unauthorized repairs or incorrect parts use; or (5) are used for commercial or other income producing purposes.

How do you obtain service?

All warranty repairs must be authorized by XDP Recreation Customer Service Assistance Department before repairs are made. **IMPORTANT: There is NO NEED to return the entire unit to the store where it was purchased!** In order to obtain quick service provided by this warranty, you may call or email the details using the below contact:

Customer Support:

8:00 AM to 5:00 PM Monday through Friday (Eastern Standard Time) - 1-866-884-0535

Or email us at service@xdp-recreation.com or via fax at 1-770-886-2746

Further info can be found at www.xdp-recreation.com

REGISTER YOUR PURCHASE

PLEASE VISIT OUR WEBSITE at www.xdp-recreation.com to register your purchase using the manufacturer date code found on the label on the swing set. There also is a short on-line survey which you can fill out to complete the registration.

DO NOT RETURN TO RETAILER YOU PURCHASED AT.
CONTACT XDP FOR PARTS AND SUPPORT AT 1.866.884.0535 or service@xdp-recreation.com